

Service
Service
Service

Service Manual

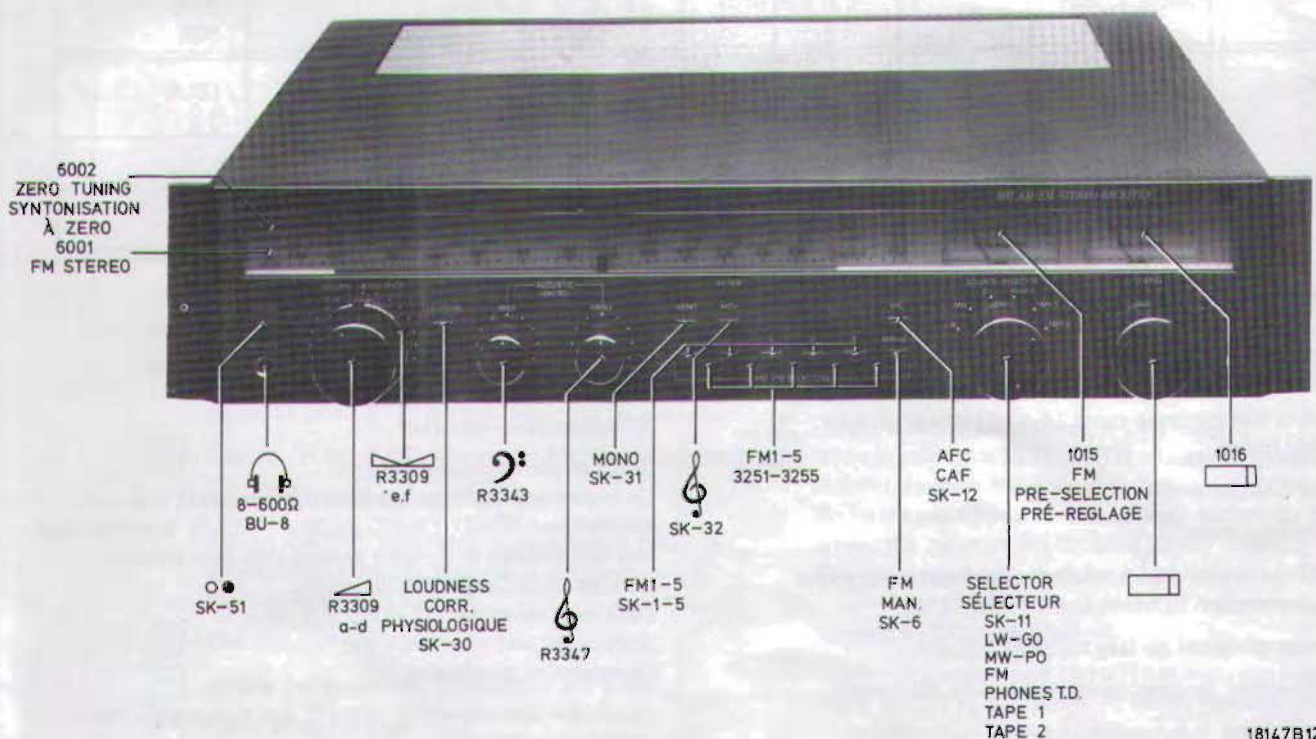

18147B12



Service
Service
Service

Service Manual

(GB)

The 22AH603/60/62/65 are identical with the 22AH603/00/12/15 respectively, with exception of the following parts.

(NL)

De 22AH603/60/62/65 zijn gelijk aan resp. de 22AH603/00/12/15 met uitzondering van de onderstaande onderdelen.

(F)

A l'exception des pièces suivantes les 22AH603/60/62/65 sont identiques aux 22AH603/00/12/15.

(D)

22AH603/60/62/65 sind den Geräten 22AH603/00/12/15 identisch mit Ausnahme folgender Teile.

(S)

22AH603/60/62/65 är lika med versionerna 22AH603/00/12/15 fränsett följande ändringar.

(SF)

Seuraavia muutoksia lukuunottamatta 22AH603/00/12/15:n huolto-ohjetta voidaan käyttää 22AH603/60/62/65 yhteydessä

407+406	4822 426 50405
408	4822 413 51047
409	4822 413 51046
411,412	4822 413 40857
413	4822 413 51045
414	4822 413 51044
419	4822 410 22231
425,438	4822 410 22232
426	4822 450 80629
431	4822 410 22228
439	4822 410 22229
442	4822 410 22227



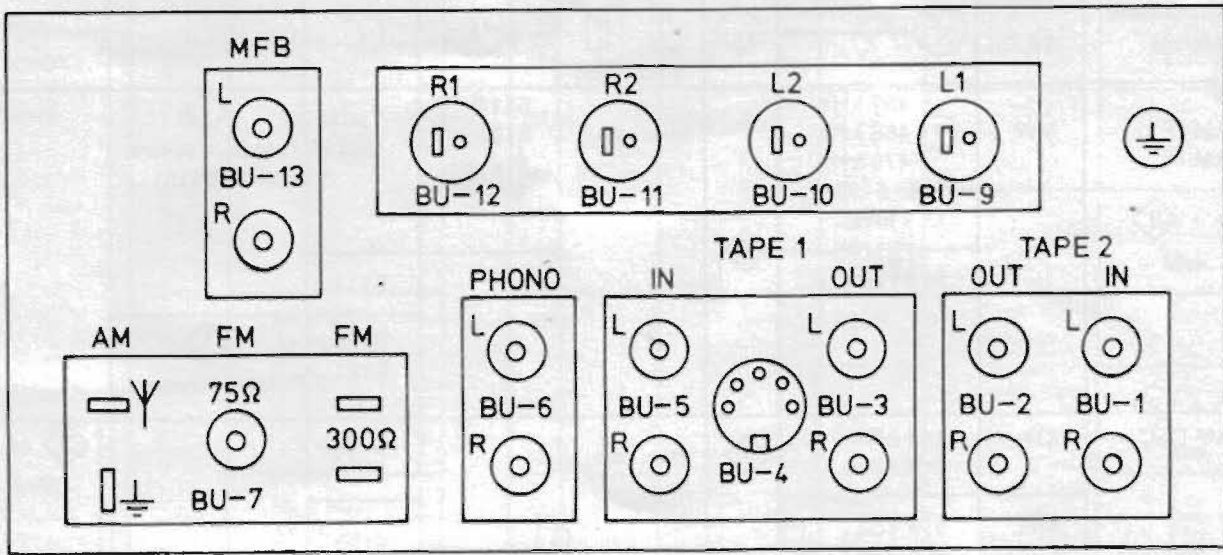

17182A10

BU-1		1		150 mV	(100 kΩ)
BU-2		1		120 mV	(2,5 kΩ)
BU-3		2		120 mV	(2,5 kΩ)
BU-4		2	1,4	0,25 mV/kΩ	(220 kΩ)
			3,5	150 mV	(100 kΩ)
BU-5		2		150 mV	(100 kΩ)
BU-6				2,5 mV	(47 kΩ)
BU-7			FM	300 Ω	
			FM	75 Ω	
			AM	300 Ω	
BU-8				350 mV (8 Ω)	
				3 V (1 kΩ)	
BU-9		L1		30 W (8 Ω)	
BU-10		L2			
BU-11		R2			
BU-12		R1		30 W (8 Ω)	
BU-13				2,5 V (1 kΩ)	

Alignement Réglage	SK...								
AM-IF AM-FI	MW	1 452 kHz 468 kHz 470 kHz (=fo 5115) (+ 1 kHz)	A	Min. cap.	5111 5121 ↕ 5120		1 Max. + symm. (=fo 5115)		
									fo 5115
AM-OSC	LW	147 kHz (+ 1 kHz)	A	Max. cap.				2 or 3 Max.	
	MW	512 kHz (+ 1 kHz)							5123
		1635 kHz (+ 1 kHz)		Min. cap.	5122	2197			
AM-RF	MW	600 kHz (+ 1 kHz)	A					2 or 3 Max.	
	LW	155 kHz (+ 1 kHz)							5118
	MW	1500 kHz (+ 1 kHz)							5119
FM-IF	FM	2 ± 10.7 MHz Δf 250 kHz (50 Hz)	B	Min. cap.	5107 5109 5113	5112	4 + 5 Max. + symm.		
		± 10.7 MHz	C						5107 5109 3
						5113 6	6 + 7 4	5 6 + 7 < 20 mV ...	

- GB
- 1 Before proceeding to trimming, short-circuit point 14 of IC 6111 by connecting it to the mass.
 - 2 Switch off the AFC (automatic frequency control)
Interrupt solder bridge .
Adjust the R.F. generator in such a way that a symmetrical response curve is obtained on the screen (= fo 5110).
 - 3 The input signal shall be as low as possible.
 - 4 Adjust for maximum linearity of the S-curve.
 - 5 Close solder bridge .
 - 6 Adjust for zero-axis crossing (red LED shall burn glaringly).
 - 7 Mark at scale.
 - 8 Meter deflection ≥ 8 divisions.
 - 9 Eliminate short-circuit at point 14 of IC 6111.

Adjustment output amplifier

Direct current adjustment – Left (Right).
With the aid of R3527 (3523) adjust the quiescent current through the output transistors to $50 \text{ mA} \pm 5\%$.
To be measured with a non-earthed mV-meter connected across the resistors 3505, 3507 (3506, 3508).
The deflection shall then be $32 \text{ mV} \pm 5\%$.

Inspection DC protection

- Connect a resistor of $180 \text{ k}\Omega$ between the negative pole of C2411 and point +1 of the power supply.
The relay shall then be released.
- Connect a resistor of $150 \text{ k}\Omega$ between the negative pole of C2414 and point -1 of the power supply.
The relay shall then be released.

Alignement Réglage	SK...									
FM-HF	FM	109 MHz Δf 75 kHz 1 mV		Max.			5108 			
		86.8 MHz Δf 75 kHz 1 mV					Min.		2106 	+ Max.
		95.5 MHz Δf 75 kHz 1 mV							3258	
						5105	+ Max.			
						3257 				
STEREO DECODER	FM	19 kHz \pm 2 Hz 100 mV				5114		or Min.		
		100 MHz + pil. tone + R. Mod.			10 nF 15 16 IC6111	3179		 Min.		

Stereo Decoder - Décodeur Stéréo - Decodificatore stereo - Stereodekoder

1015	FM			95.5 MHz		3149		1015 95.5
				108 MHz		3151		1015 108
1016	PU					3217		1016 0
	MW							600 kHz 10 mV

↑ Repeat - Herhalen - Répéter - Wiederholen - Repetera - Ricominciare - Gentage - Gjntagelse - Toista

NL

- Vóór het trimmen punt 14 IC 6111 kortsluiten met massa.
- AFC uitschakelen.
Soldeer brug open
RF generator zo instellen dat de doorlaatkromme symmetrisch in beeld komt (= fo 5110).
- Ingangssignaal zo laag mogelijk houden.
- Afregelen op max. lineariteit van de S-kromme.
- Sluit brug .
- Afregelen op 0-doorgang (Rode LED moet fel branden).
- Merkpunt op schaal.
- Meteruitslag \geq 8 schaaldelen.
- Kortsluiting punt 14 IC 6111 opheffen.

Afregelen eindversterker

Gelijkstroominstelling - L(R).

De ruststroom door de eindtransistoren moet ingesteld worden met R3527 (3523) op 50 mA \pm 5 % te meten met een niet geaarde mV-meter aangesloten over de weerstanden 3505, 3507 (3506, 3508).

De uitslag moet dan 32 mV \pm 5 % zijn.

Controle DC beveiliging

- Sluit een weerstand van 180 k Ω aan tussen de - (min pool) van C2411 en de +1 voeding.



Het relais moet dan afvallen.

- Sluit een weerstand van 150 k Ω aan tussen de - van C2412 en de -1 voeding.

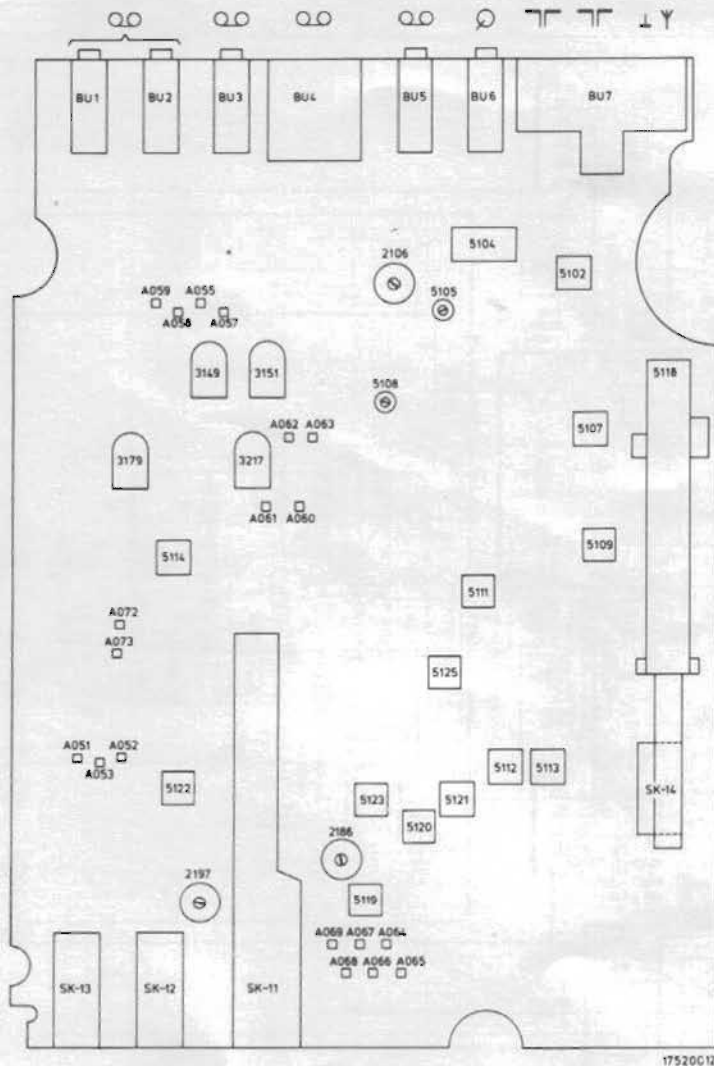
Het relais moet dan afvallen.



F

- 1 Avant de procéder à l'alignement, relier le point 14 du CI 6111 à la masse.
- 2 Mettre hors circuit la C.A.F. (commande automatique de fréquence).
Interrompre le pont de soudure .
Régler le générateur RF de façon que la courbe de réponse obtenue sur l'écran soit symétrique. (= fo 5110).
- 3 Le signal d'entrée sera aussi bas que possible.
- 4 Ajuster de manière à obtenir une linéarité maximale de la courbe en S.
- 5 Fermer le pont .
- 6 Ajuster au passage par zéro (la diode LED rouge doit s'allumer vivement).
- 7 Repère sur le cadran.
- 8 Déviation de l'appareil de mesure ≥ 8 divisions de l'échelle.
- 9 Eliminer le court-circuit du point 14 du CI 6111.



Réglage de l'amplificateur de sortie

Ajustage courant continu – gauche (droit).
Par action sur R2527 (3523) régler le courant de repos à travers les transistors de sortie pour avoir $50 \text{ mA} \pm 5 \%$.
A mesurer à l'aide d'un mV-mètre isolé de la terre, connecté aux bornes des résistances 3505, 3507, (3506, 3508).
La déviation doit être alors de $32 \text{ mV} \pm 5 \%$.

Contrôle de la protection contre le courant continu

- Connecter une résistance de $180 \text{ k}\Omega$ entre le pôle négatif de C2411 et le point +1 de l'alimentation. Ceci fait, le relais doit se décrocher.
- Connecter une résistance de $150 \text{ k}\Omega$ entre le pôle négatif de C2412 et le point -1 de l'alimentation. Ceci fait, le relais doit se décrocher.

D

- 1 Vor dem abgleich ist Punkt 14 von IC 6111 gegen Masse kurzzuschliessen.
- 2 AFC ausschalten.
Lötbrücke  öffnen.
Hf-Generator dahin einstellen, dass die Durchlasskurve symmetrisch ins Bild kommt. (= fo von 5110).
- 3 Eingangssignal möglichst niedrig halten.
- 4 Auf Höchstlinearität der S-Kurve abgleichen.
- 5 Lötbrücke  schliessen.
- 6 Auf Nulldurchgang abgleichen (rote Leuchtdiode soll grell aufleuchten).
- 7 Marke auf Skala.
- 8 Ausschlag des Messgeräts: ≥ 8 Skalenteile.
- 9 Kurzschluss an Punkt 14 von IC 6111 beheben.

Abgleich des Endverstärkers

Gleichstromeinstellung – L (R).
Der Ruhestrom durch die Endtransistoren soll mit R3527 (3523) auf $50 \text{ mA} \pm 5 \%$ eingestellt werden; zu messen mit einem nicht-geerdeten mV-Meter, über die Widerstände 3505 und 3507 (3506 und 3508) angeschlossen.
Der Ausschlag soll dann $32 \text{ mV} \pm 5 \%$ sein.

Kontrolle der Gleichspannungssicherung

- Einen Widerstand von $180 \text{ k}\Omega$ zwischen Minusleiter von C2411 und +1-Stromversorgung anschliessen. Das Relais soll dann abfallen.
- Einen Widerstand von $150 \text{ k}\Omega$ zwischen Minusleiter von C2412 und -1 Stromversorgung anschliessen. Das Relais soll dann abfallen.

I

- 1 Prima di procedere alla taratura, cortocircuitare il punto 14 del IC 6111 collegandolo a massa.
- 2 Disinserire l'AFC (controllo automatico di frequenza).
Interrompere il ponticello .

Regolare il generatore R.F. in modo che si ottenga una curva di risposta simmetrica sull'oscillatore (= fo 5110).

- 3 Il segnale d'ingresso deve essere il più basso possibile.
- 4 Regolare per la massima linearità della curva ad S.
- 5 Chiudere il ponticello .
- 6 Regolare la curva per il passaggio sullo zero dell'ascissa (il led rosso si illuminerà al massimo).
- 7 Punto di riferimento sulla scala.
- 8 Indicazione dello strumento \geq al punto 8.
- 9 Togliere il cortocircuito dal piedino 14 del IC 6111.

S

- 1 Kortslut stift 14 på IC 6111 till jord innan trimningen påbörjas.
- 2 AFC i läge FRÅN.
Öppna bryggan .

Ställ in signalgeneratoren så att en symmetrisk kurva erhålls på oscilloskopet (= fo 5110).

- 3 Insignalen skall vara så låg som möjligt.
- 4 Justera för max linjäritet på S-kurvan.
- 5 Stäng bryggan .
- 6 Justera för nollaxelgenomgång (röd LED skall lysa ordentligt).
- 7 Markeringen på skalan.
- 8 Mätarutslag \geq 8 delstreck.
- 9 Tag bort kortslutningen på stift 14 IC 6111.

DK

- 1 Inden trimningen påbegyndes, kortsluttes punkt 14 på IC 6111 til stel.
- 2 Afbryd AFC (automatisk frekvenskontrol)
Fjern loddeforbindelsen .

Juster generatoren således, at der opnås en symmetrisk responcekurve på skærmen (= fo 5110).

- 3 Indgangssignalet skal holdes så lavt som muligt.
- 4 Juster S-kurven til maximum linearitet.
- 5 Monter atter loddeforbindelsen .
- 6 Indjuster nulovergangen, således at den røde "LED" lyser.
- 7 Sæt et mærke på skalaen.
- 8 Meter-udslaget skal være større end, eller lig med 8 streger.
- 9 Husk at fjerne kortslutningen ved punkt 14 på IC 6111.

Regolazione dell'amplificatore d'uscita

Regolazione della corrente di riposo canali sinistro (destra). Per mezzo di R3527 (3523) regolare la corrente di riposo attraverso i transistor d'uscita a $50 \text{ mA} \pm 5 \%$. Questa misura deve essere fatta con il mVmetro, senza il collegamento alla presa di terra, ai capi delle resistenze 3505, 3507 (3506, 3508). La variazione può quindi essere di $32 \text{ mV} \pm 5 \%$.

Controllo del circuito di protezione in DC

- Collegare una resistenza di $180 \text{ k}\Omega$ tra il polo negativo di C2411 e il punto +1 dell'alimentazione. Il relè sarà quindi sganciato.
- Collegare una resistenza di $150 \text{ k}\Omega$ tra il polo negativo di C2412 e il punto -1 dell'alimentazione. Il relè sarà quindi sganciato.

Inställning av slutsteg

Ställ in vilostrommen för vänster (höger) kanal med hjälp av R3527 (3523) så att den blir $50 \text{ mA} \pm 5 \%$ genom sluttransistorerna. Mät med en ickejordad mV-meter över resistorerna 3505, 3507, (3506, 3508). Spänningen skall vara $32 \text{ mV} \pm 5 \%$.

Kontroll av DC-skydd

- Anslut en resistor på $180 \text{ k}\Omega$ mellan den negativa polen på C2411 och +1 på nätspänningsaggregatet. Härvid skall reläet lösa ut.
- Anslut en resistor på $150 \text{ k}\Omega$ mellan den negativa polen på C2412 och -1 på nätspänningsaggregatet. Härvid skall reläet lösa ut.

Justering af udgangsforstærker

Jævnstrømsjustering – venstre (højre). Ved hjælp af R3527 (3523) justeres hvilestrømmen gennem udgangstransistorerne til $50 \text{ mA} \pm 5 \%$ målt med et mV-meter over modstandene 3505, 3507 (3506, 3508). Udslaget skal da være $32 \text{ mV} \pm 5 \%$.

Kontrol af DC-beskyttelses kredse

- Forbind en modstand på $180 \text{ k}\Omega$ fra den negative pol på C2411 og til punkt +1 på strømforsyningen. Reläet skal da udløses.
- Forbind en modstand på $150 \text{ k}\Omega$ fra den negative pol på C2412 og til punkt -1 på strømforsyningen. Reläet skal da udløses.

M	6104	6105	6106	6101,6129,6108,6252,6251,6107	6102,6103	6118	6109	6112	6110,6122,6123,3015	6111	6131	1016,6124 - 61				
S	5101	5102,5117,5118	5104	5105	5108,5119,5124	5106	5107,5120 - 5123	5109	5111	5115	5112	5113	3125			
C	2001-2170	2102	2052,2103,2113,2104	2106,2102,2101,2109	2108,2051,2110	2112,2120,2114 = 2118,2122,2111,2123,2144,2134,2129	2125,2127,2126	2130,2141	2134	2131 - 2133	2188	2180	2182			
C	2171-2511	2185	2197	2182	2193	2196	2194	2195,2186	3101-3103,3111,3112,3108,3104,3200,3110,3105 = 3107,3109,3113-3116,3051,3152	3118-3124	3131,3130,3147 = 3151	3125 - 3128	3143	3135	3129	3132 - 3134
R	3001-3204	3215,3251 + 3256	3237 - 3264	3236,3279 - 3221,3200	3205	3207	3217,3216									

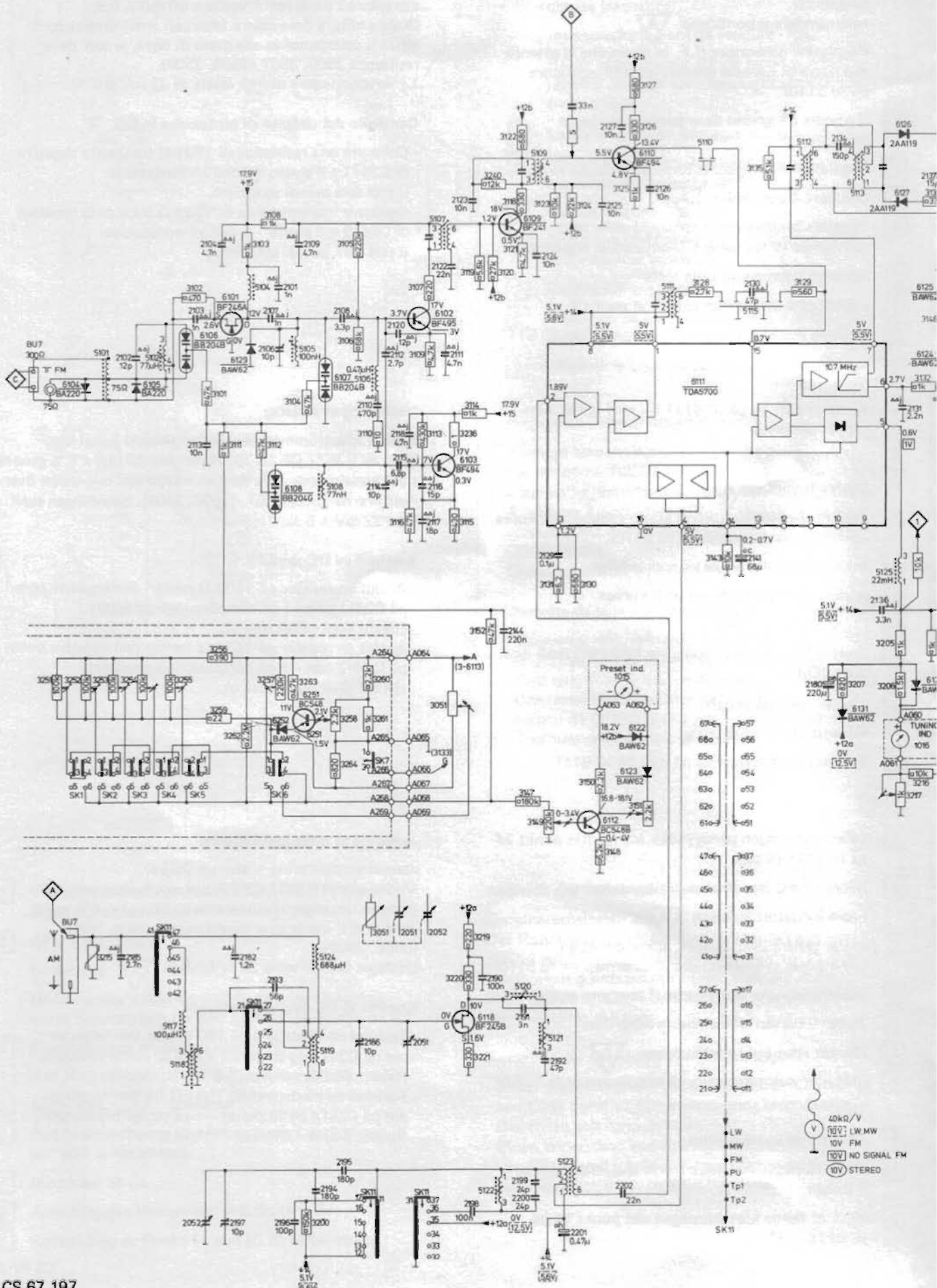

6133	6116,6117	8527	6115,6519,6516,6513	6001 1151	5124,6517	1013 1012	1011 1010	1152
			514				5001	
36 + 2140	2170,2169	2152	2149	2150	2001,2146 + 214A, 2153 - 2156, 2151	2142, 2143, 2145, 2157 - 2160, 2002	2161, 2162	
	2203	2205, 2206	2171, 2301, 2772	2508, 2511	2513, 2514			2178, 2175
	3136 + 3141, 3183, 3164 - 3169	3170 3158	3172	3157	3171, 3179	3180	3155 3156, 3162, 3153, 3181	3173, 3174, 3177, 3178
	3225	3226 + 3229	3207, 3301	3525, 3214	3523, 3524	3239	3531 - 3533	3234
						3231, 3232, 3233, 3234, 3209 - 3213		

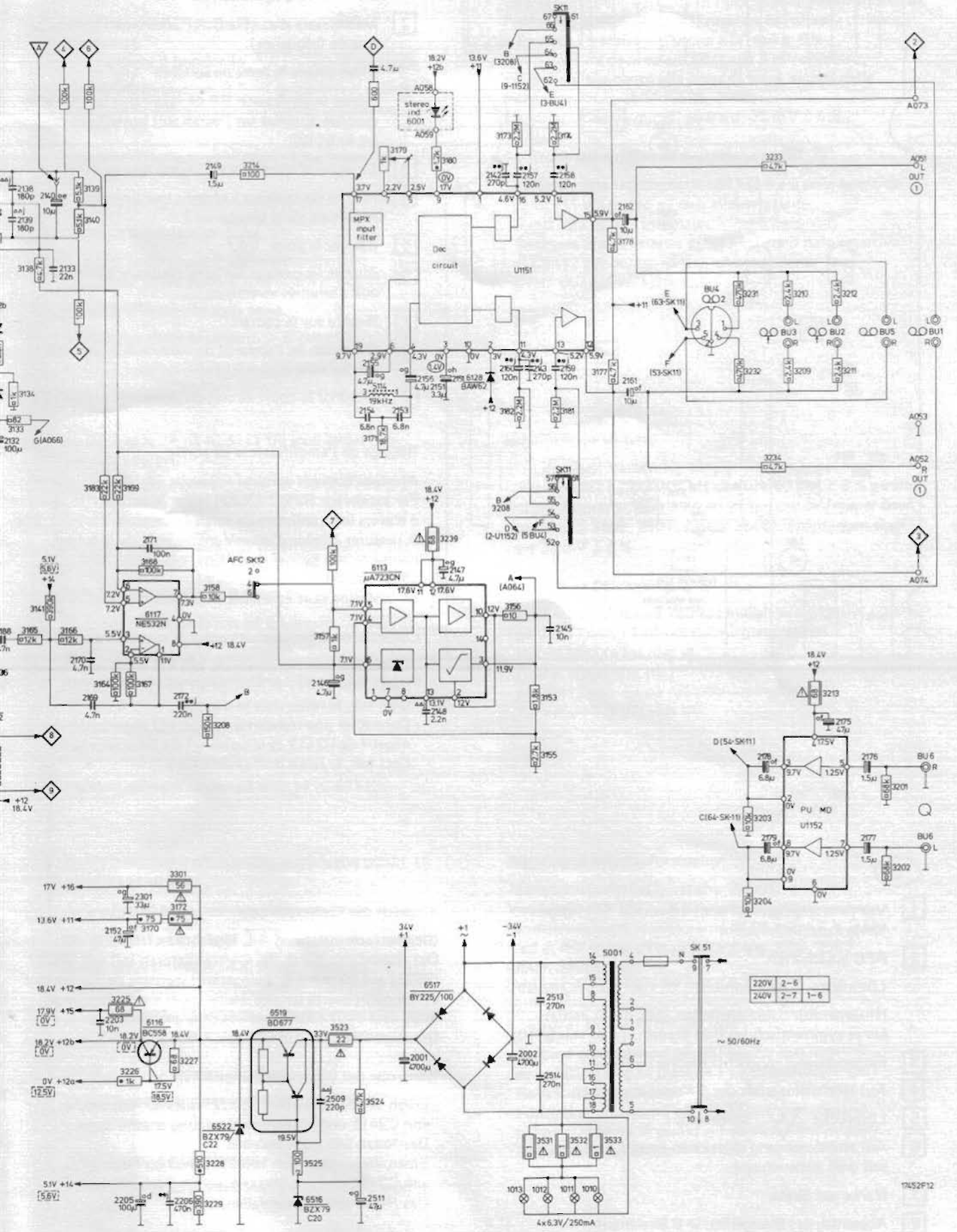

7052P12

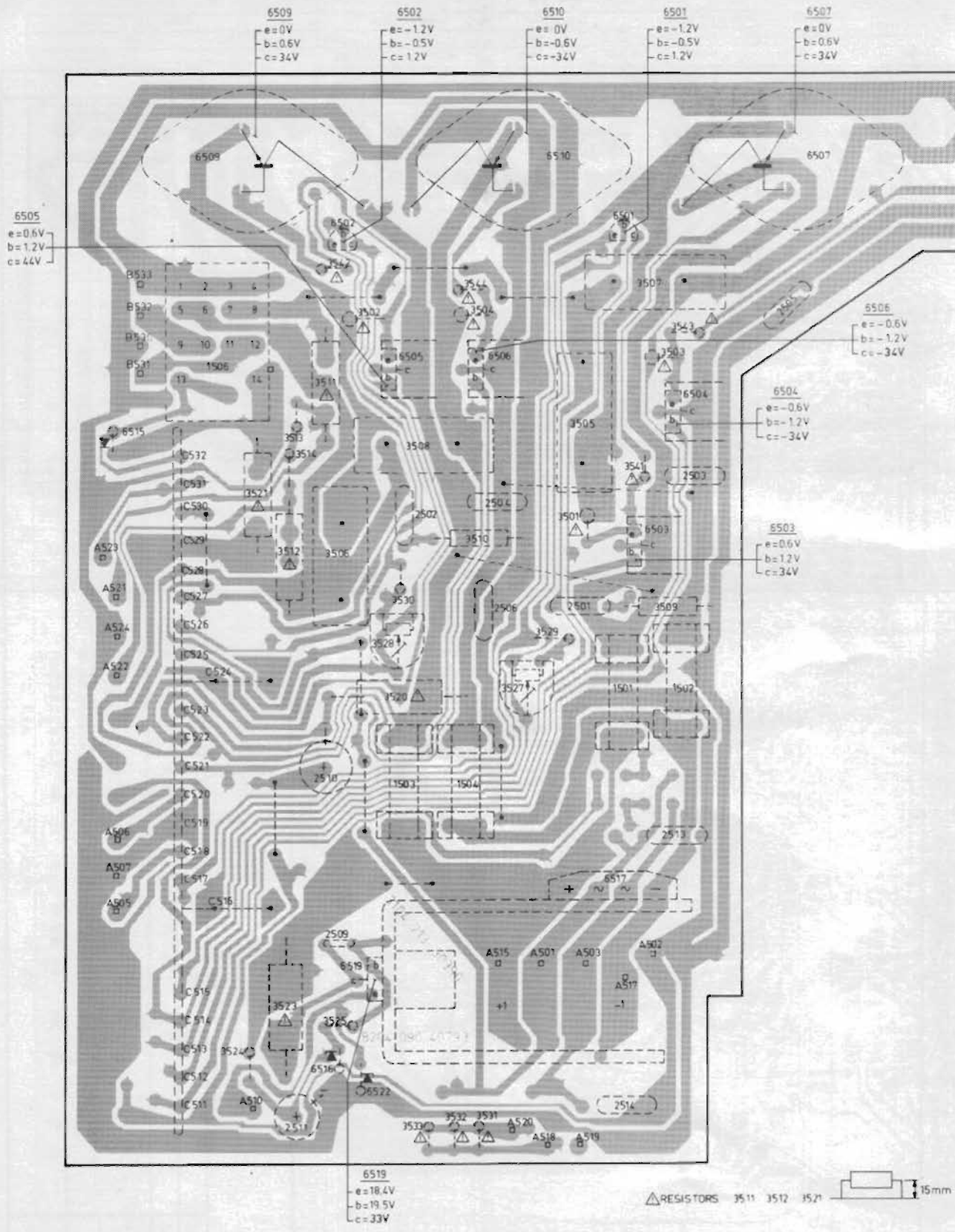

8508

e=0V
b=-0.6V
c=-34V

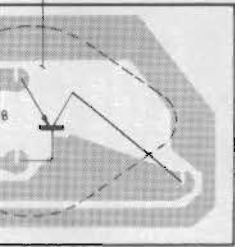

25	35	65
		09
		10
		07
		08
		02
		01
	42	
	07	
	44	
05	04	
	02	
	43	
		05
	03	06
	11	
		05
	04	
	13	15
		08
	14	
		41
03	21	
04	01	
02		03
	10	
	06	
	12	
		30
		09
06	01	
		29
		28
		27
		20
		10
		13
		35
		38
		36
		17
		09
		23
		19
		25
		24
		16
		22
14		
11	31	
	32	
	33	
25	35	65

18000D12

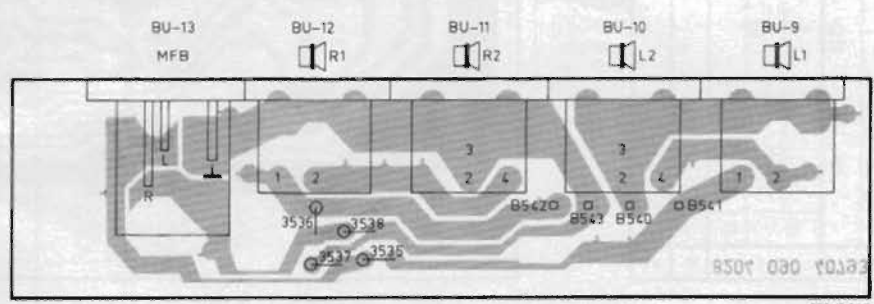
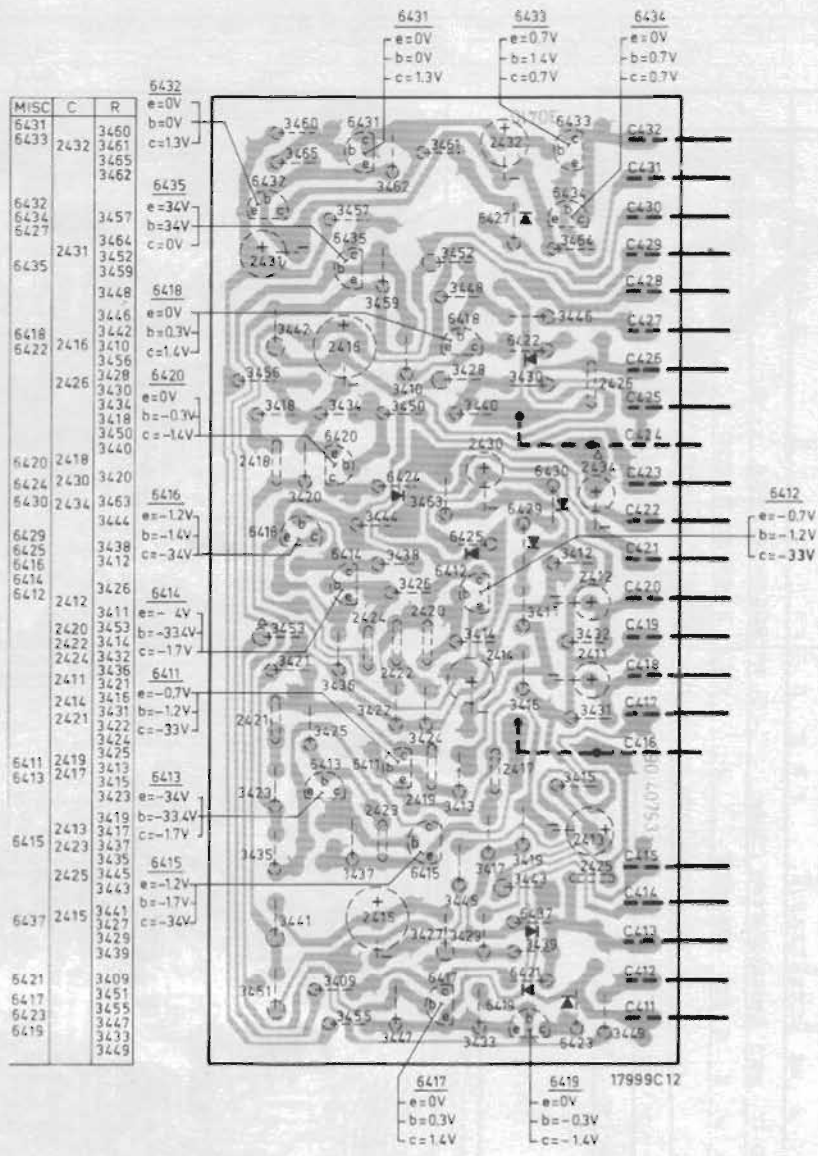

17215A12

21	3	51	61
	31	32	
75	31	32	01
77	13	10	05
76	12	04	04
78	01	02	
	11	09	
47			
45			
03			
01			
46	02	39	01
07	56	26	04
02	2203	25	02
		07	
10	10	27	05
08	06	38	06
04	03	80	02
20	11	72	15
12	04	09	
11	01	13	
09	12	05	
14	48	50	
15	49	51	
16	08	70	
17	16	79	
44	15	52	
	55	17	
43	47	16	
22		18	
	53	17	
	80	71	
42	19	05	
24	20	07	
49	22	21	
	21	14	
	69	28	
	18	29	
	31	40	
	31	77	
	36	78	
	41	66	
	23	73	
	25	08	
	29	09	
	2202	24	
	88	29	
	62	30	
	25	67	
	57	64	
	2206	46	
	27	82	
	58	25	
	59	32	
	71	68	
	43	74	
	34	81	
	82		
	2201	12	
	95	13	
		24	
	90	19	
	40	22	
	38	23	
	91	21	
	37	20	
	2200	18	
	92	20	
	99	21	
	32	00	
	96	21	
	86	00	
		20	
	93	19	
	97		
	58		
	95		
	94		
21	3	51	61

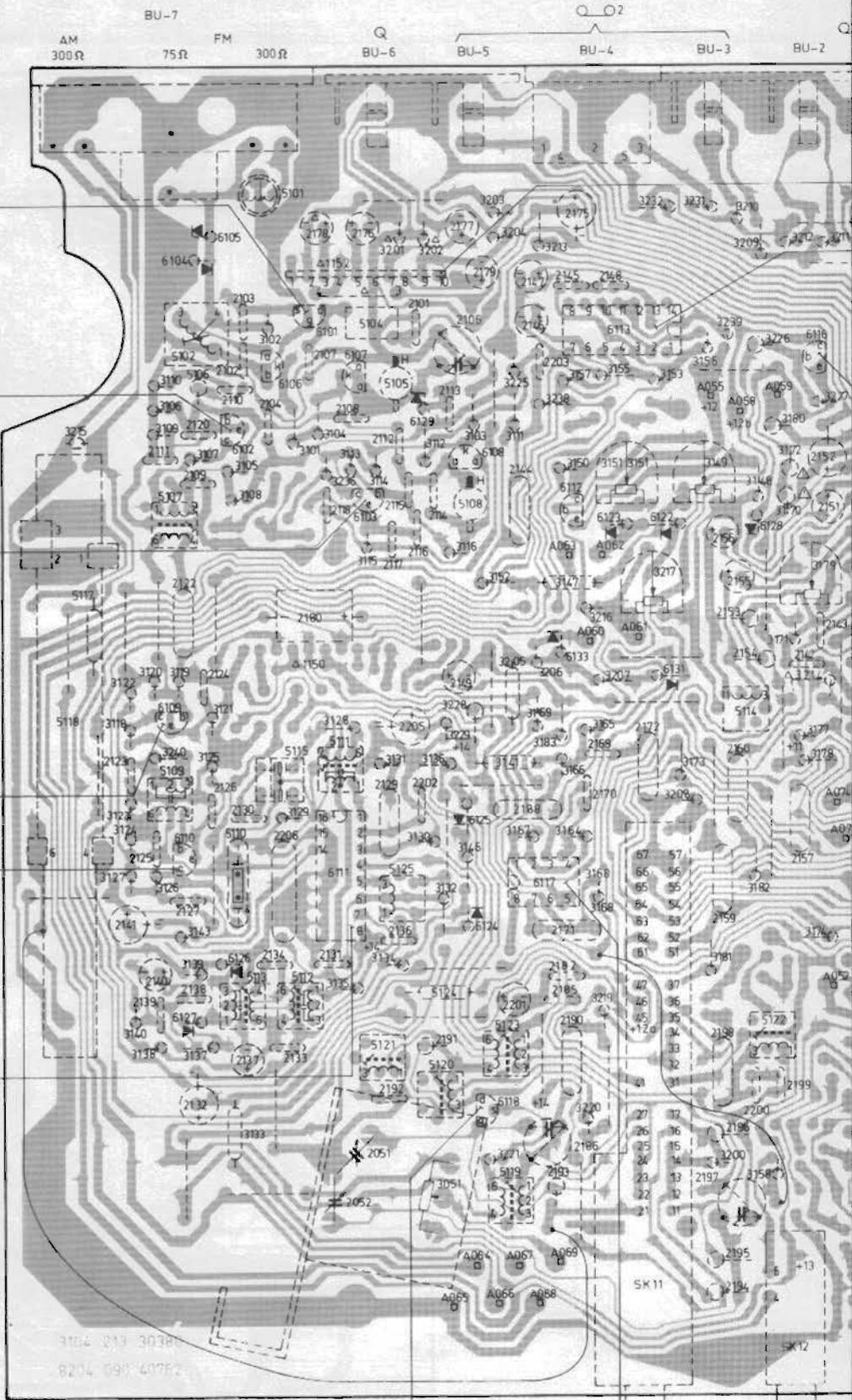

5101
g=0V
d=12V
s=2.6V

5102
e=3V
b=3.7V
c=17V

5103
a=17V
b=1V
c=0.3V

5109
e=0.5V
b=1.2V
c=18V

5110
e=4.8V
b=5.5V
c=13.4V

5111
1=5V [5.5V]
2=1.9V
3=1.2V
4=5V [5.5V]
5=0.6V [IV]
6=2.7V
7=5V [5.5V]
8=5V [5.5V]
9-13=
14=0.2-0.7V
15=0.7V
16=0V

5118
g=0V
d=16V
s=10V

5117
1=11V
2=5.5V
3=5.5V
4=0V
5=7.2V
6=7.2V
7=7.3V
8=18.4V

MISC	6252	6251	SK6	SK5	SK7	SK4	SK3	SK2	SK1
R	3256	3264	3255	3254	3253	3252	3251		

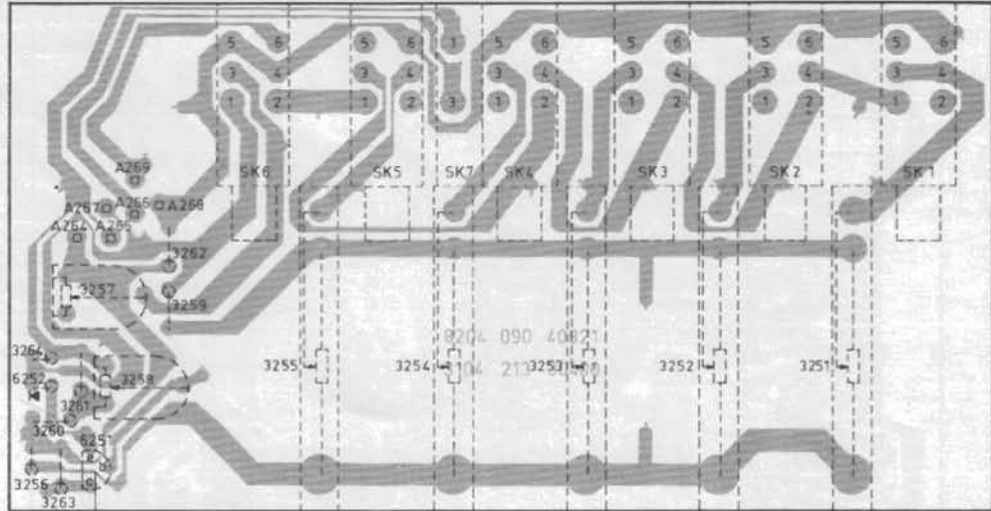
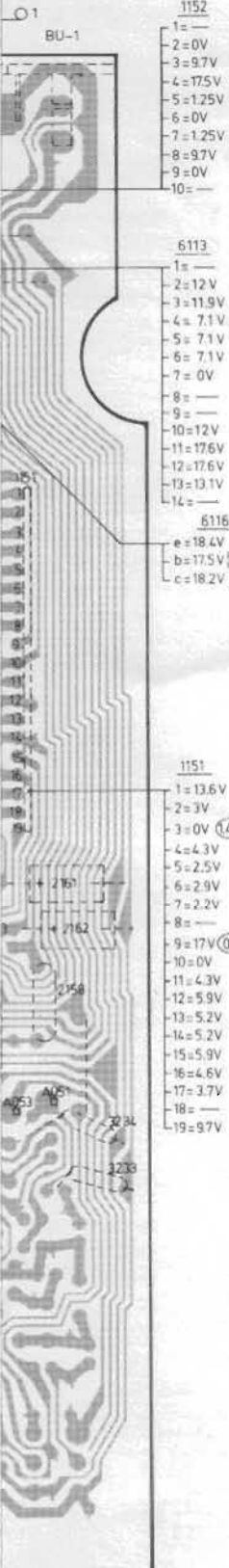

6251

- e=1.5V
- b=2.1V
- c=11V

17214B12

18003D12

	6301.6302	6305.6304
2303+2306	2307+2310	2311+2316
3303+3309	3315+2320	3321+3326
		3329+3332
		3341

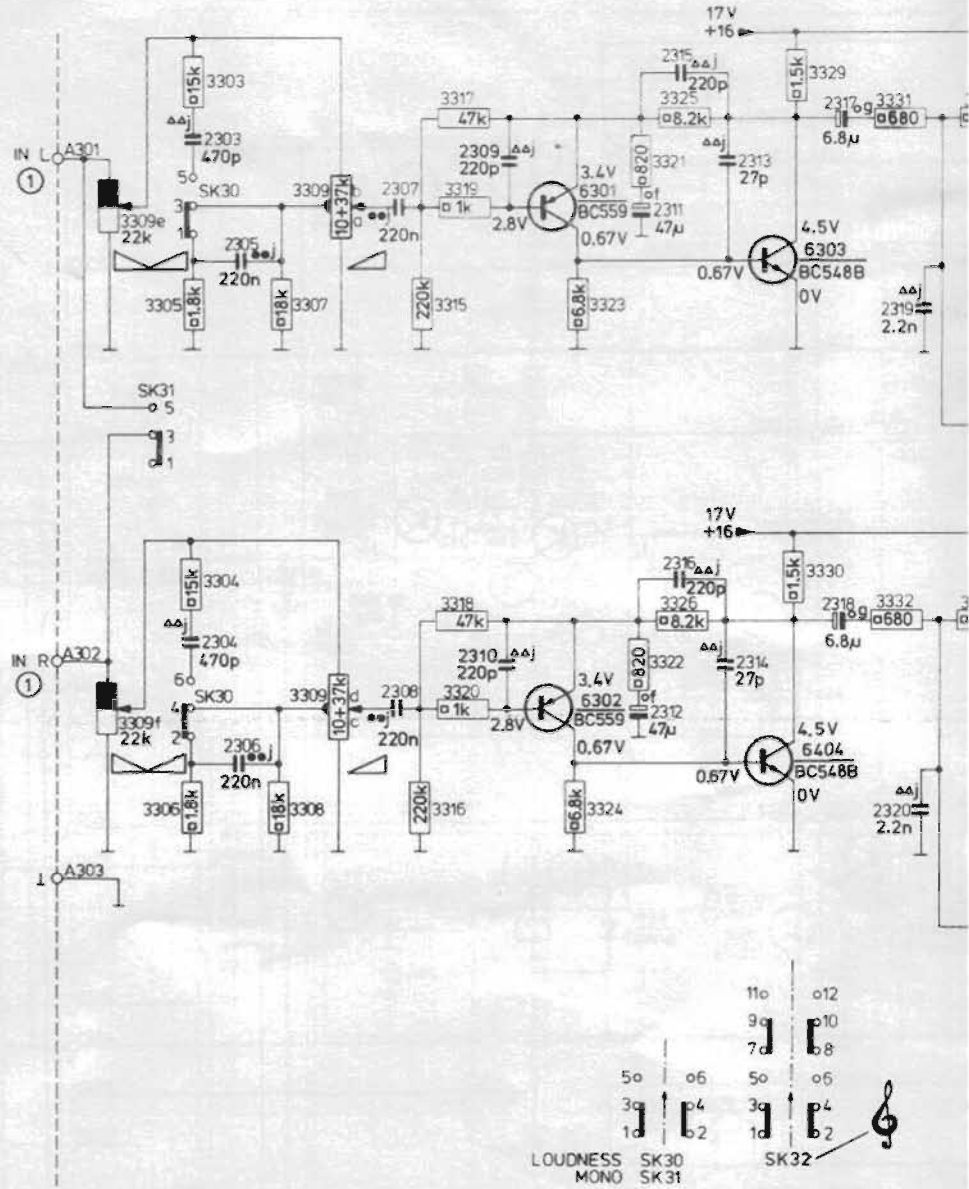

MISC	6301	SK 30	6302	6303	6304	6308	630
C	2305	2303	2312	2319	2310	2322	2320
C	2307	2304	2308	2309	2306	2311	2315
R	3309	3303	3307	3305	3308	3306	3331
R		3315	3304	3323	3316	3321	3325
							3329
							3324
							3322
							3326
							3330
							3352
							3360
							3356

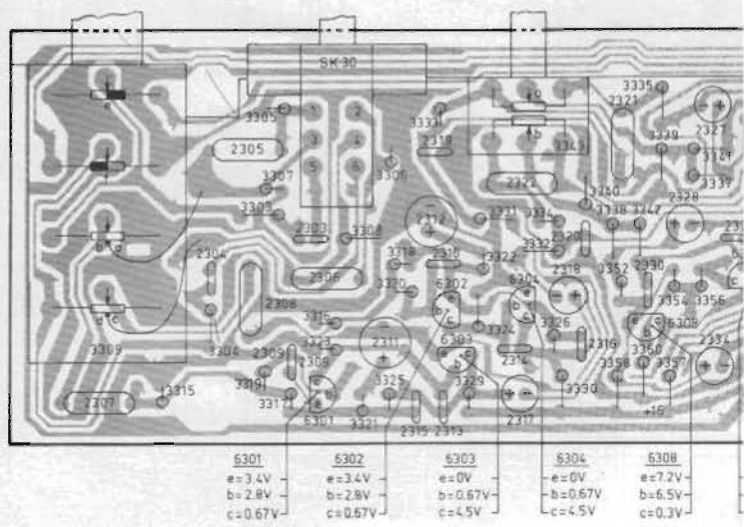

6301	6302	6303	6304	6308
e=3.4V	e=3.4V	e=0V	e=0V	e=7.2V
b=2.8V	b=2.8V	b=0.67V	b=0.67V	b=6.5V
c=0.67V	c=0.67V	c=4.5V	c=4.5V	c=0.3V

6305+6308			
2321+2424	2327+2330	2333,2334	2335,2336
3347,3333+3340,3341+3345	3351+3356	3357+3362	

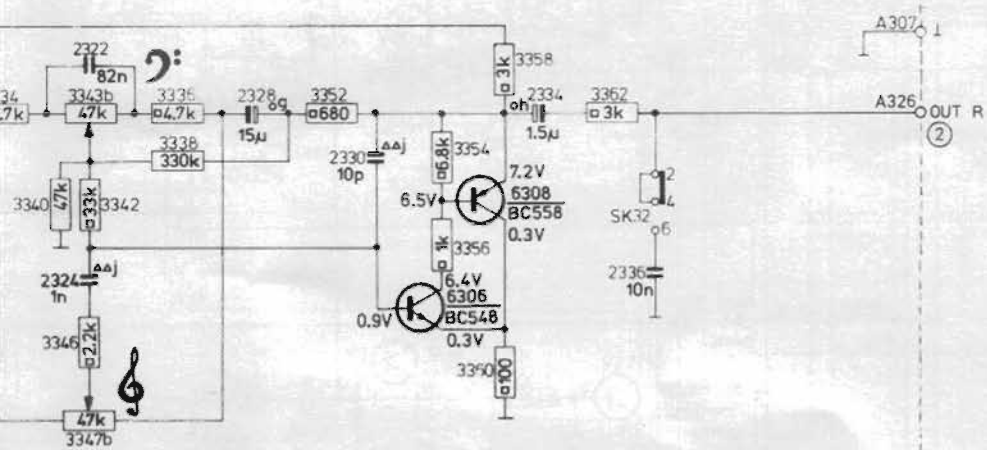
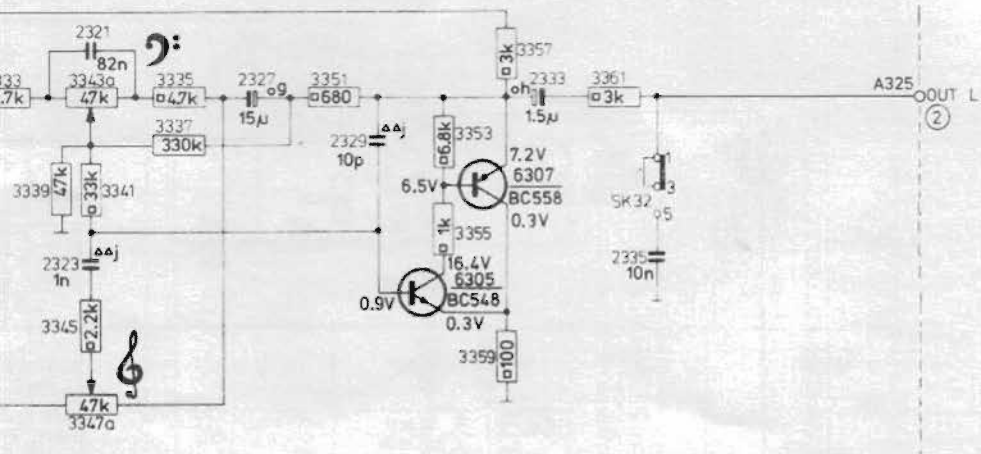

1745D12

6307	6305	SK 31	SK 32	SK 33	SK 34
2329, 2323	2335	2336	2337	2338	
2301, 2333					
3346, 3347, 3351, 3355, 3345, 3359		3363	3364	3366	
3354, 3301, 3362, 3353, 3361				3365	

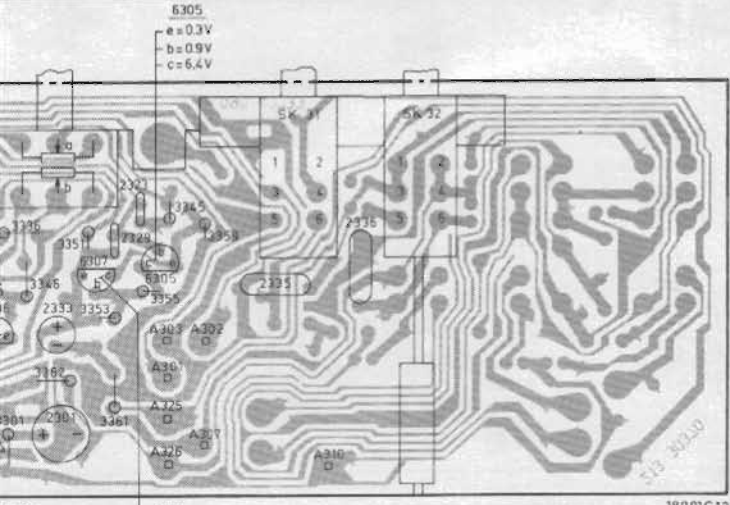

6305	6307
e=0.3V	e=7.2V
b=0.9V	b=6.5V
c=6.4V	c=0.3V

M	6427,6429,6430	6431	6411,6412,6432	6413+6416	6435	6421+6425,6417-64
C	2411,2412	2430	2413+2422,2431	2423+2426	2432	2432
R	3463,3432,3431,3461,3465,3411+3424,3460,3456	3455,3425-3430,3436=3444,3457,3459,3410,3409,3462	344	343	343	344

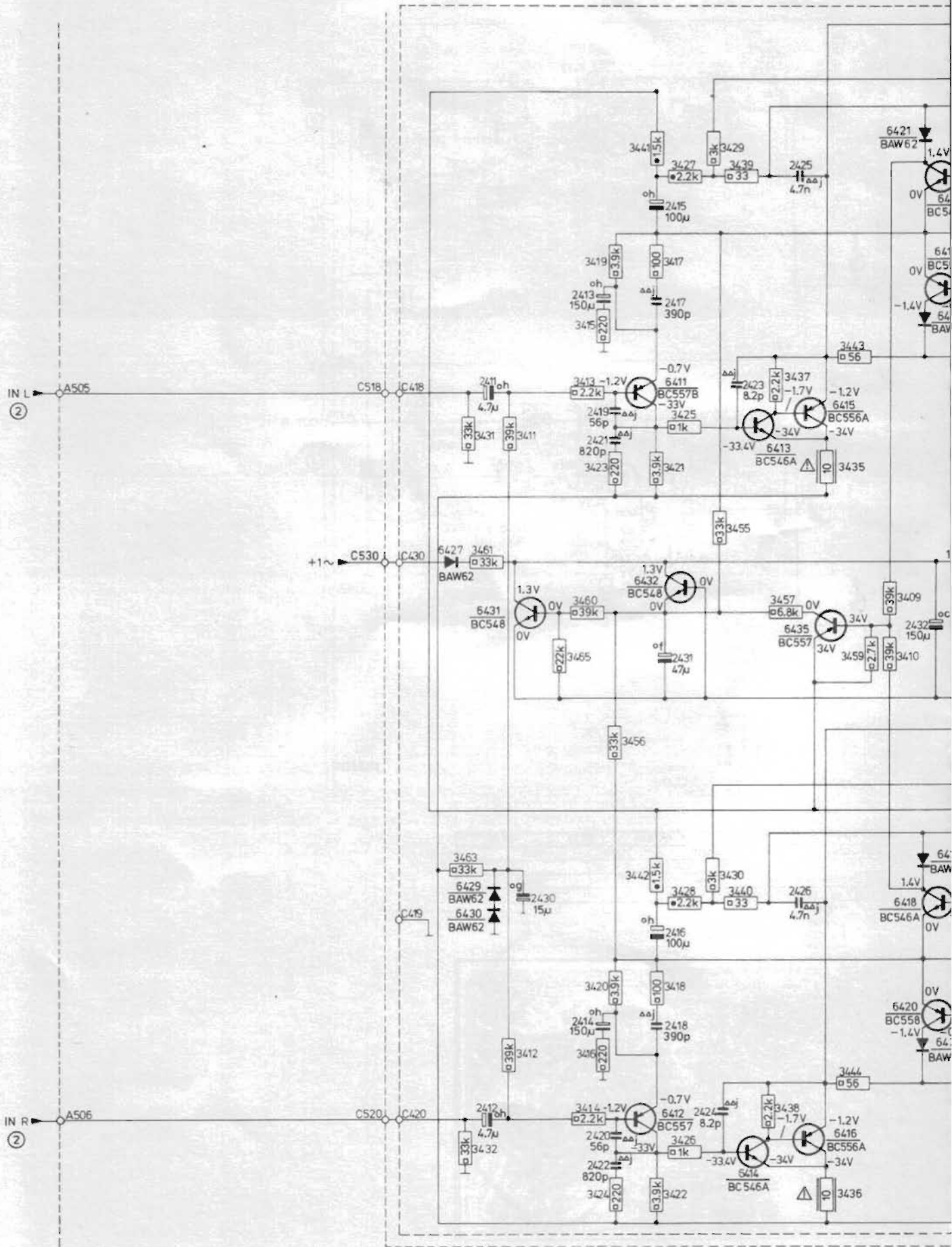

0.6433	6434	6515.6501+6506	1506	6507-6510	1502.1503
			2510	2505.2506.2501.2502	2503.2504
-3450.3433.3434.3464		3527-3530	3520.3521.3501+3508.3541-3544.3509.3510		3511-3514
					3535-3538

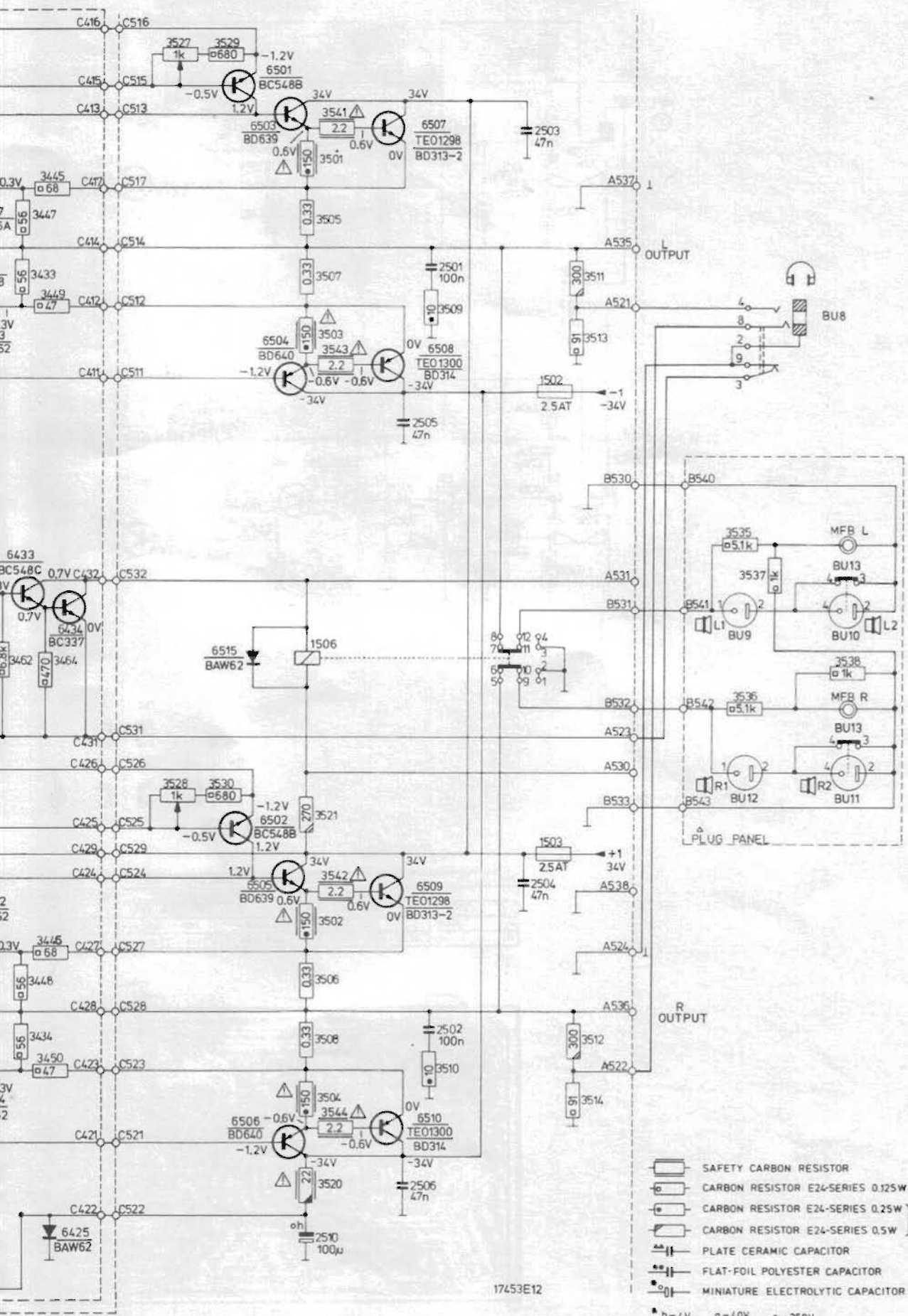

17453E12

- SAFETY CARBON RESISTOR
- CARBON RESISTOR E24-SERIES 0.125W 5%
- CARBON RESISTOR E24-SERIES 0.25W } < 1MΩ 5%
- CARBON RESISTOR E24-SERIES 0.5W } > 1MΩ 10%
- PLATE CERAMIC CAPACITOR
- FLAT-FOIL POLYESTER CAPACITOR
- MINIATURE ELECTROLYTIC CAPACITOR

b = 4V g = 40V r = 250V
 c = 6.3V h = 63V s = 350V
 d = 10V j = 100V u = 400V
 e = 16V m = 150V
 f = 25V q = 200V

A

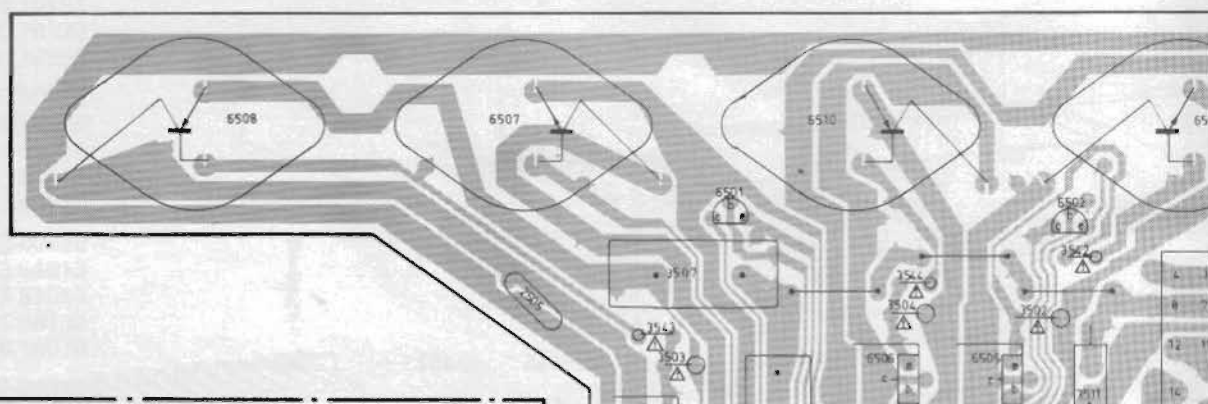

B

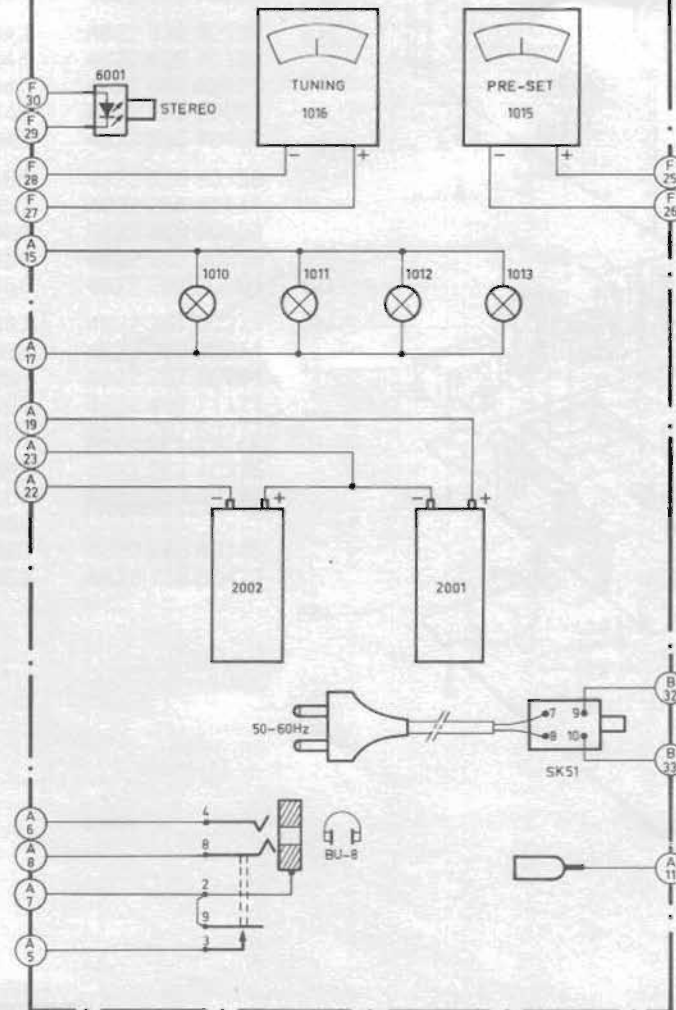
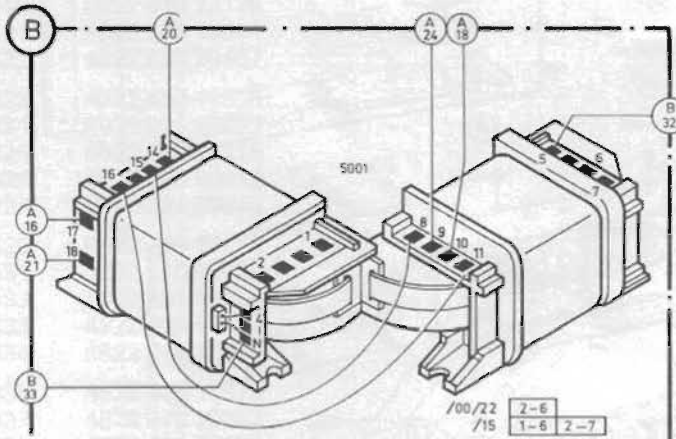

B

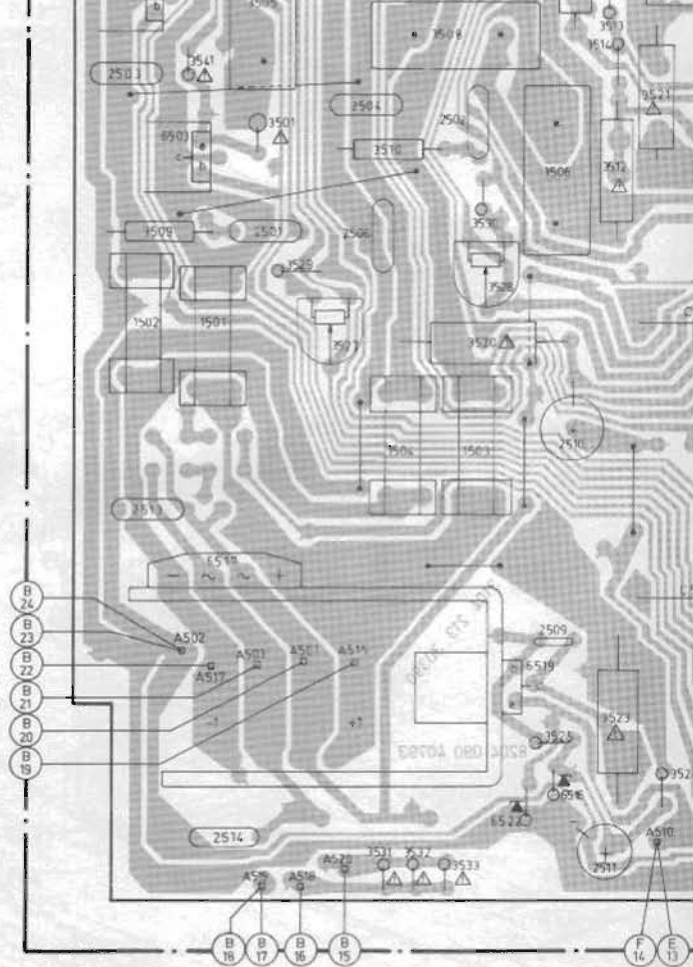

E

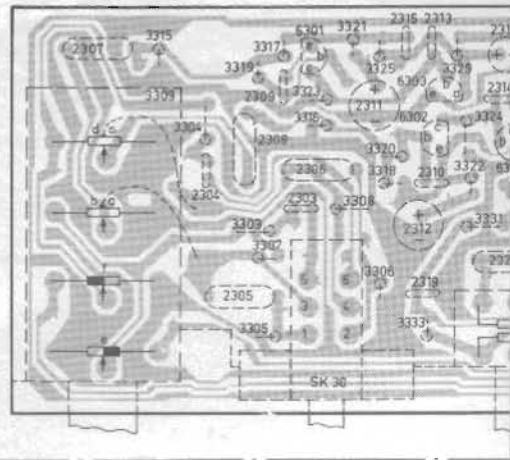

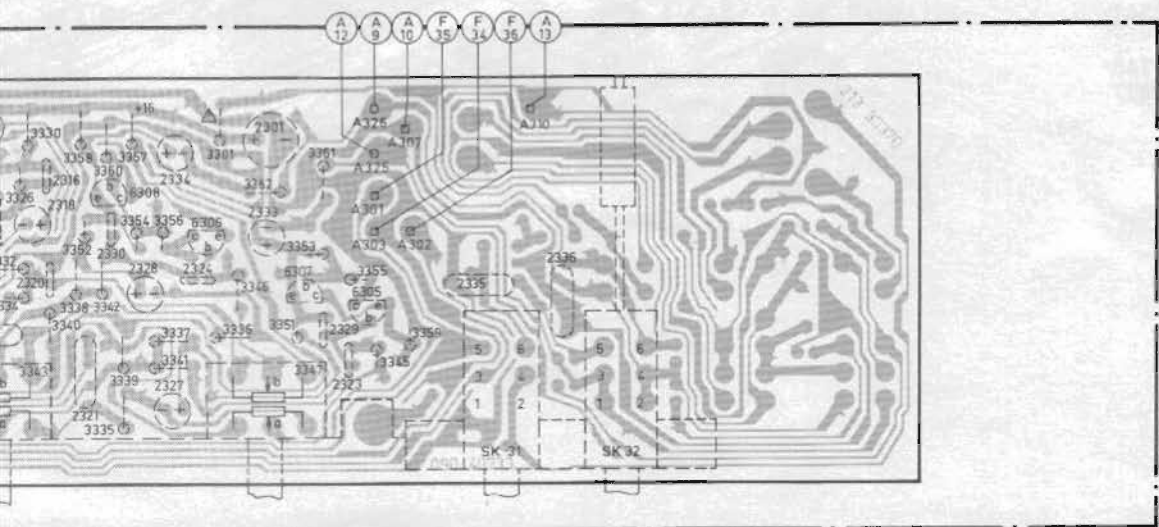
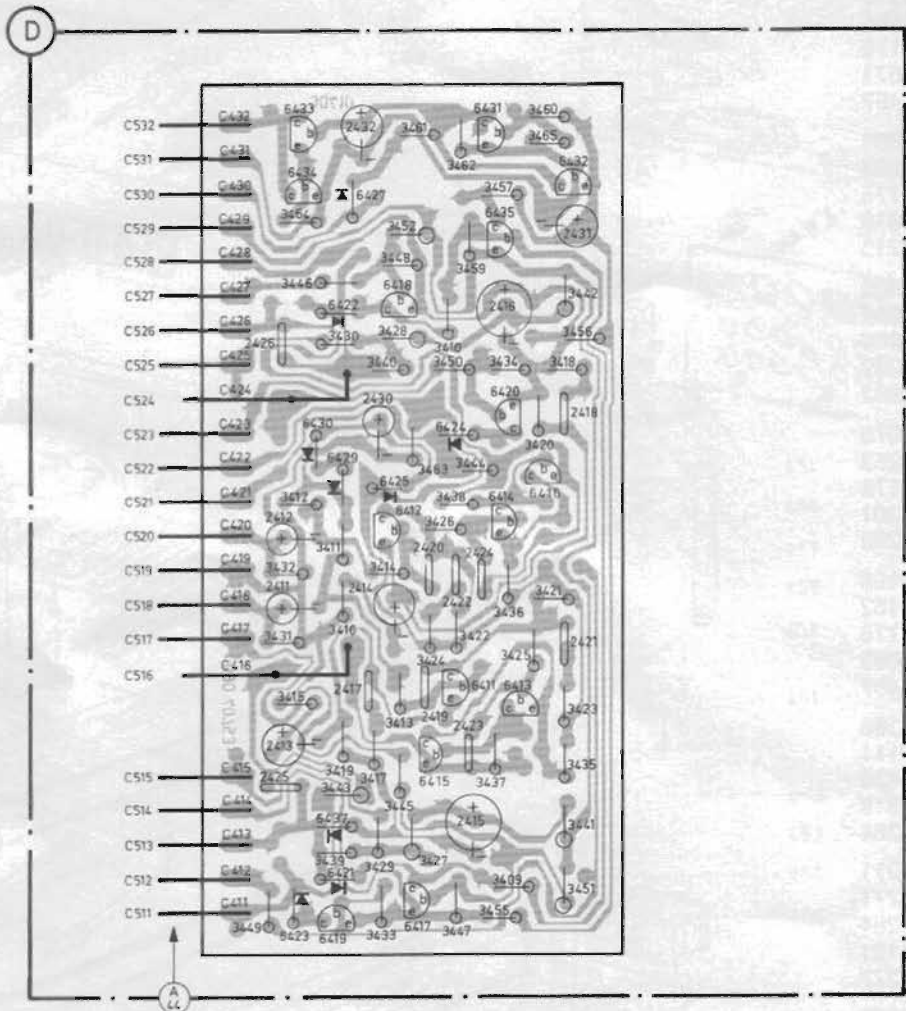
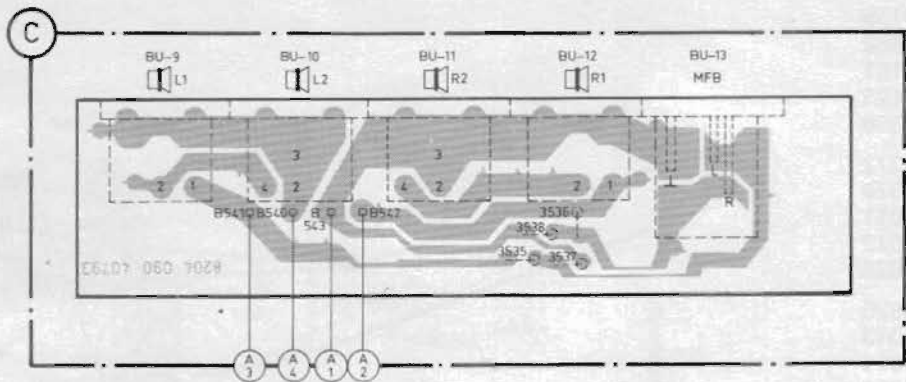
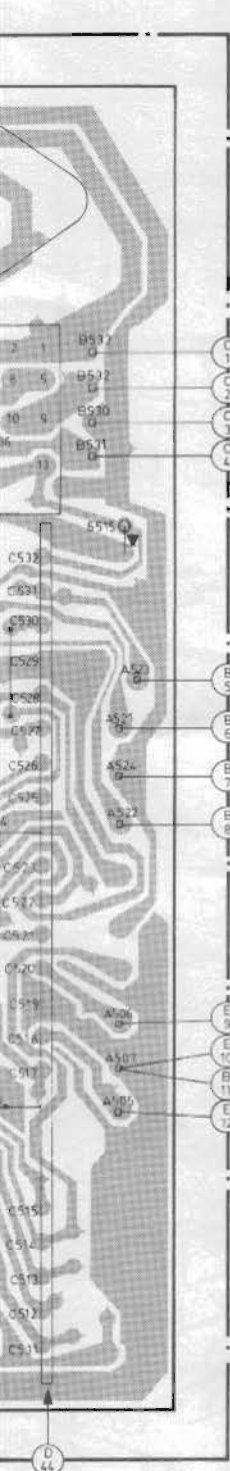

MISC	C	C	R	R
6508				3536
6507				3538
6510				3535
6509				3537
6501				
6502				
2505				3542
				3507
				3544
				3504
				3502
				3543
				3503
6506				
6505				
1506				
6504				3505
6515				3513
				3508
				3514
6433	2503	2432	3521	3460
6431			3521	3461
				3465
				3462
6432	2504		3501	
6434				3510
6427				3512
6503				3506
6435				3452
5001		2431		
				3530
				3459
				3509
				3448
				3446
				3442
6418	2501			
6422	2506			
		2415	3529	3410
			3528	3428
		2426		3430
				3456
1502				3440
1501				3440
6420				3527
1504		2430		3520
1503		2418		3450
6430				3434
6424				3418
6423				3420
				3420
				3463
				3443
6425				3412
6414				3438
6418	2412			3426
6412				3411
	2513			2420
				2424
				2432
				3414
6001				2411
6517				3421
				3436
				3416
				3415
				3421
				3424
				3425
6411	2509		2414	3427
6413		2417		3415
6519				3415
				2419
				3413
				2423
				3423
				2413
6415				3419
				3417
				3435
				3427
				3427
				3443
				3443
1010			2415	3445
1013				3441
6437				3439
6516				3429
6522	2514			3427
6421				3427
6417	2511			3409
6423				3451
6419				3455
1401				3449
				3433
				3447
2002				
6301	2317	3321		
	2301	3315		
	2307	3317	3330	
	2334	3325	3358	
6303	2309	2314	3329	3357
	2311	2316	3319	3301
			3323	3360
6308	2308		3309	3361
6302		2316	3316	3362
6304		2333	3304	3324
6306	2306	2336	3320	3326
	2310		3318	
SK51	2304	2328	3322	3352
6307	2303	2324	3308	
6305	2312	2320	3331	3356
		2335	3303	3332
		2336	3334	3346
			3307	3338
	2322		3329	3342
BU-8	2319	2323		3340
	2305		3343	3337
	2321	2327	3333	3336
			3305	3351
			3339	3359
			3335	
SK30				3347
SK32				3345

- 401 4822 255 40158
- 402 4822 333 50568
- 403 4822 255 10151
- 404 4822 530 70123
- 406 4822 466 70356

- 407 4822 426 50372
- 407/28 4822 426 50378
- 408 4822 413 51011
- 409 4822 413 51012
- 411 4822 413 40826

- 412 4822 413 40826
- 413 4822 413 51013
- 414 4822 413 51014
- 415 4822 395 50133
- 416 4822 276 10579

- 417 4822 267 30319
- 418 4822 528 80186
- 419 4822 410 22176
- 421 4822 505 10571
- 422 4822 535 70457

- 423 4822 492 40658
- 424 4822 276 10692
- 425 4822 410 22175
- 426 4822 450 80618
- 427 4822 321 30215

- 428 4822 492 31495
- 431 4822 410 30202
- 432 4822 101 90086
- 433 4822 532 51099
- 434 4822 276 10692

- 436 4822 273 10076
- 437 4822 276 20253
- 438 4822 410 22175
- 439 4822 410 30201
- 441 4822 276 50258

- 442 4822 410 30198
- 446 4822 426 40162
- 447 4822 492 62176
- 448 4822 492 60063
- 449 4822 535 70457

- 451 4822 528 80186
- 452 4822 255 40111
- 453 5322 466 90433
- 454 4822 267 30318
- 456 4822 267 30264

- 457 4822 267 30271
- 458 4822 267 30271
- 459 4822 267 30264
- 461 4822 462 71121
- 462 4822 267 50277

- 463 4822 267 40325
- 464 4822 267 40341
- 465
- 466 4822 265 40145
- 469 4822 158 60427

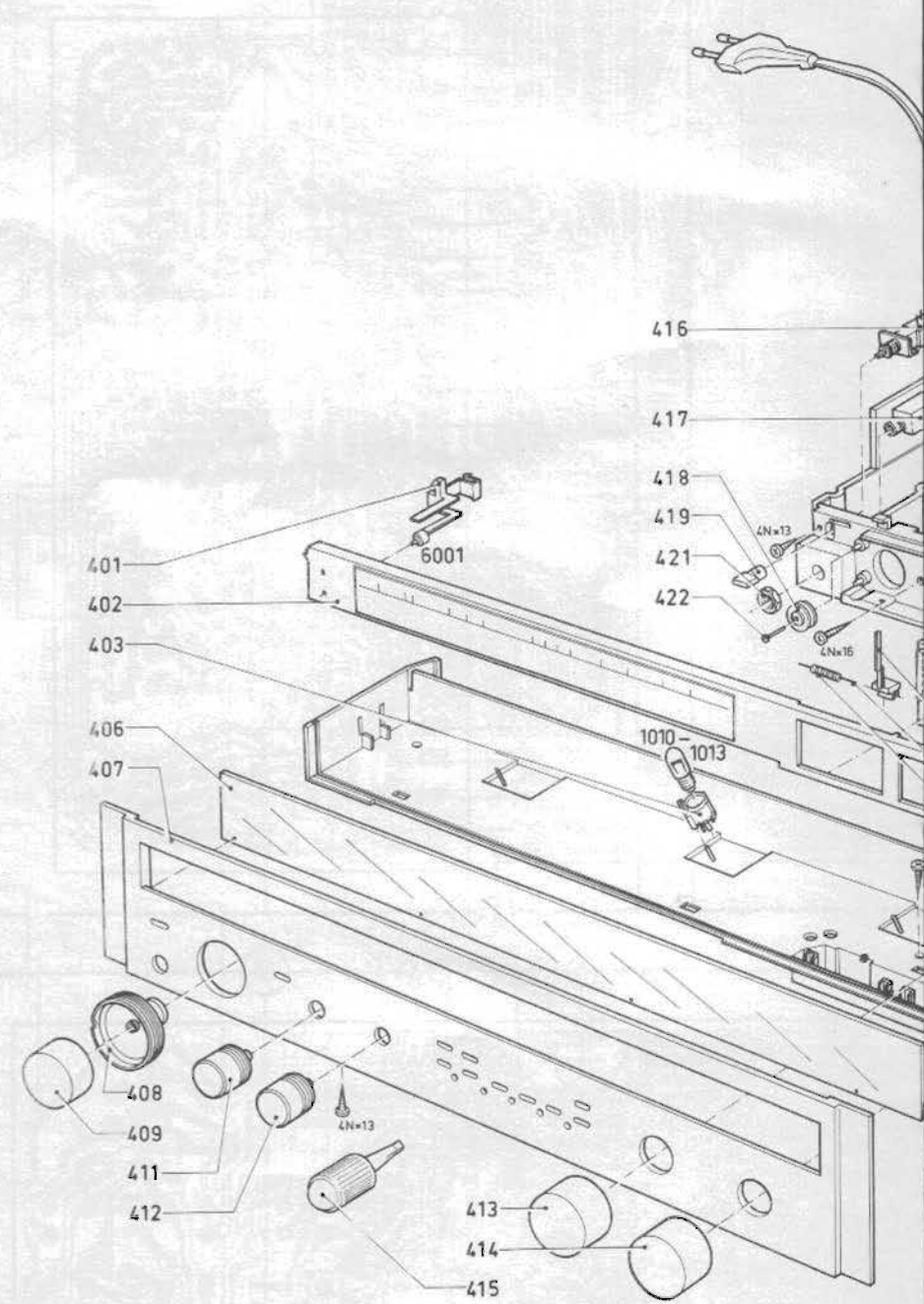
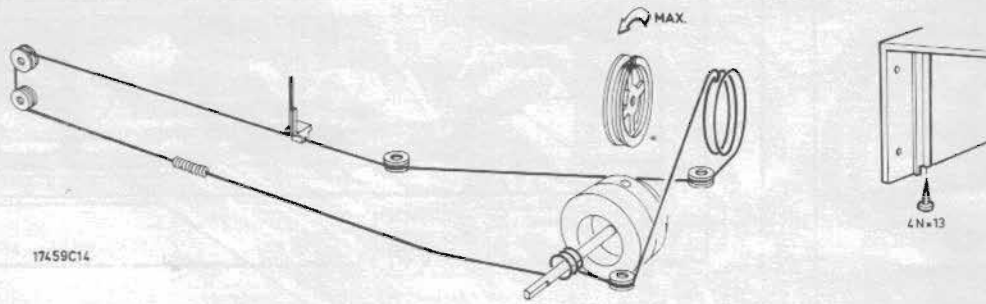

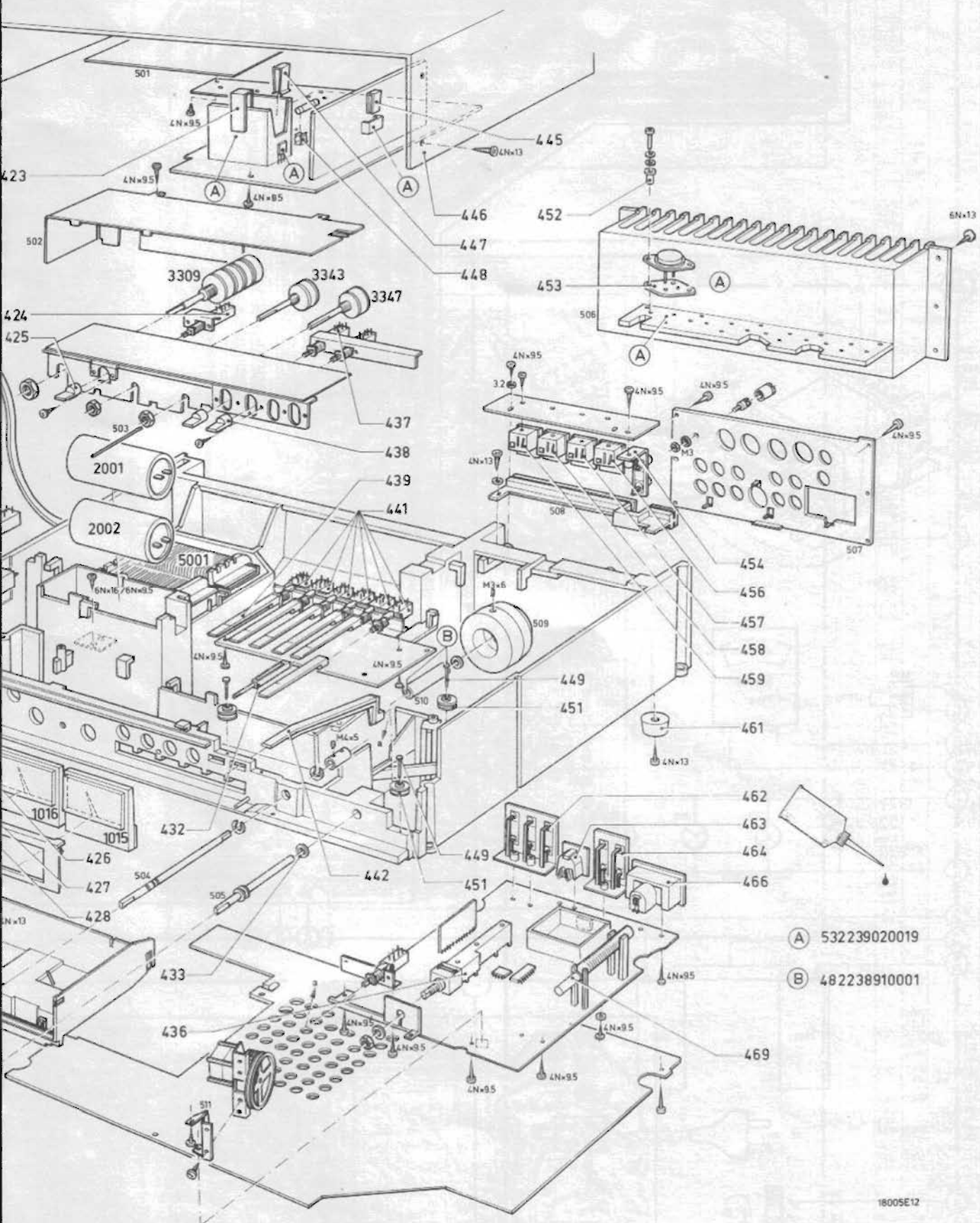

- (A) 532239020019
- (B) 482238910001

18005E12

-TS-					
6101	BF246A	5322 130 44798	5001		4822 146 30333
6102,6110	BF494	4822 130 44195	5101	300.75	4822 146 30324
6103	BF495	4822 130 40947	5105	77 nH	4822 157 50973
6109	BF241	4822 130 40898	5106	0.47 μH	4822 157 50967
6112	BC548C	4822 130 44196	5107	10.7MC	4822 153 50116
6116	BC558	4822 130 40941	5108	50 nH	4822 157 50895
6118	BF245B	4822 130 41024	5109	10.7MC	4822 153 50205
6251	BC548	4822 130 40938	5110	10.7MC.SFJ10.7	4822 242 70287
6301,6302	BC559	4822 130 40963	5111	452 KC	4822 156 20816
6303,6304	BC548B	4822 130 40937	5112		4822 153 50207
6305,6306	BC548	4822 130 40938	5113		4822 153 50208
6307,6308	BC558	4822 130 40941	5114	19 KC	4822 156 20743
6411,6412	BC557B	4822 130 44568	5115	468KC SFZ468	4822 242 70275
6413,14,17,18	BC546B	4822 130 41067	5115	452KC SFZ452	4822 266 20069
6415,6416	BC556A	5322 130 44462	5117	100 μH	4822 157 50964
6419,6420	BC558	4822 130 40941	5118		4822 158 60427
6431,6432	BC548	4822 130 40938	5119	LW	4822 156 20817
6433	BC548C	4822 130 44196	5120		4822 156 30582
6434	BC337	4822 130 40855	5121		4822 156 30583
6435	BC557	4822 130 44256	5122,5123	LW/MW	4822 156 20818
6501-6502	BC548B	4822 130 40937	5124	680 μH	4822 156 50968
6403-6506	BD637/638	4822 130 41056	5125	22 mH	4822 156 20743
6507,6509	TED1298 (BD313-2)	4822 130 41375	-R- 		
6508,6510	TED1300 (BD314)	4822 130 41155			
6519	BD675	5322 130 44604			
-D-					
6001		4822 130 31049	3149	220 K	4822 100 10088
6104,6105	BA220	4822 130 34221	3151	2,2 K	4822 100 10029
6106,6107	BB204b	4822 130 34449	3172	10 K	4822 100 10035
6108	BB204g	5322 130 34825	3179,3217	1 K	4822 100 10037
6112-6125, } 6128-6135 }	BAW62	4822 130 30613	3213	Safety 68 Ω	4822 111 30322
6126,6127	2-AA119	4822 130 30312	3215	VDR	4822 116 20073
6252	BAW62	4822 130 30613	3230,3217, } 3213,3225 }	Safety 68 Ω	4822 111 30426
6421-6430	BAW62	4822 130 30613	3251-3255	100 K	4822 101 90086
6515	BAW62	4822 130 30613	3257	220 K	4822 100 10088
6516	BXZ79/C20	5322 130 34499	3258	2K2	4822 100 10029
6517	BY225/100	4822 130 30917	3301	Safety 56 Ω	4822 111 30412
6522	BZX79/C22	4822 130 34441	3009	2x100+22K	4822 102 10145
			3337,3338	Metal res. 330K-2%	4822 116 51207
			3339-3340	Metal res. 47K-2%	5322 116 54671
			3343,3347	2x47K	4822 102 30313
			3435,3436	Safety 10 Ω	4822 111 30405
			3443,3444	Safety 56 Ω	4822 111 30029
			3501-3504	Safety 150 Ω	4822 111 30406
			3505-3508	W.W 3W - 0,33 Ω	4822 113 80214
			3523	Safety 22E	4822 111 50346
			3527-3528	1 K	4822 100 10037
			3532-3533	Safety 1 Ω	4822 111 30215
			3541-3544	Safety 2,2 Ω	4822 111 30437
-IC-					
6111	TDA5700	4822 209 80358			
6113	μA723CN	5322 209 84655			
6117	NE532N	4822 209 80484			

-C-	-II-		-II-	
2001-2002	4700 μ F - 40 V	4822 124 70322	2321,2322	82 nF 4822 121 41158
2106,2197	10 pF	4822 125 50062	2335,2323	10 nF 4822 121 41134
2113,2145, } 2123,2127 }	10 nF	4822 122 30043	2419-2420	56 pF - 2 % 4822 122 31074
2122	22 nF	5322 121 44204	2423-2424	8.2 pF - 2 % 4822 122 31052
2129,2171, } 2190,2198 }	0.1 μ F	4822 121 40334	2501-2502	100 nF - 100 V 4822 121 40334
2133,2143, } 2203,2204 }	22 nF	4822 122 30103	2503-2506	250 V - 47 nF 4822 121 40239
2137,2147	16 V - 15 μ F	4822 124 20883	2512	100 nF - 250 V 4822 121 40518
2153,2154	6,8 nF	4822 121 50538	2513-2514	270 nF - 100 V 4822 121 40431
2176,2177, } 2149 }	1,5 μ F - 50 V	4822 124 20828	-Miscellaneous-	
2186	5 pF	4822 125 50077	1010-1013	6,3 V - 250 mA 4822 134 40007
2188,2189		4822 125 20219	1015	4822 347 10228
2191	3 nF	4822 121 50414	1016	4822 347 10229
2193	62 pF - 1 %	4822 121 50558	1151	4822 210 30029
2194	160 pF - 1 %	4822 121 50561	1152	4822 210 20297
2195	215 pF - 1 %	5322 121 54075	1502-1503	2,5 AT 4822 253 30026
2196	113 pF - 1 %	4822 121 50702	1506	Relay 4822 280 70165

(GB)

Safety regulations require that the set be restored to its original condition and that parts which are identical with those specified, be used.

(NL)

Veiligheidsbepalingen vereisen, dat het apparaat bij reparatie in zijn oorspronkelijke toestand wordt teruggebracht en dat onderdelen, identiek aan de gespecificeerde, worden toegepast.

(F)

Les normes de sécurité exigent que l'appareil soit remis à l'état d'origine et que soient utilisées les pièces de rechange identiques à celles spécifiées.

(DK)

Myndighedernes sikkerheds- og radiostøjbestemmelser kræver, at enhver reparation skal udføres korrekt m.h.t. overholdelse af originalplacering og montering af komponenter, ledningsbundter, etc, og ved anvendelse af de foreskrevne reservedele.

(D)

Bei jeder Reparatur sind die geltenden Sicherheitsvorschriften zu beachten. Der Originalzustand des Geräts darf nicht verändert werden: für Reparaturen sind Original-Ersatzteile zu verwenden.

(I)

Le norme di sicurezza esigono che l'apparecchio venga rimesso nelle condizioni originali e che siano utilizzati i pezzi di ricambio identici a quelli specificati.

(S)

Säkerhetsbestämmelserna kräver att varje reparation skall utföras korrekt med hänsyn till ursprunglig placering av komponenter, ledningar etc. och med användning av föreskrivna reservdelar.

(GB)

For more detailed technical specifications please consult commercial documentation.

(F)

Pour l'obtention de données techniques plus détaillées veuillez consulter la documentation commerciale.

(I)

In modo da ottenere dati tecnici più particolareggiati, vi preghiamo di riferirvi alla documentazione commerciale.

(NL)

Voor meer uitgebreide technische specificaties gelieve de commerciële documentatie te raadplegen.

(D)

Für eine mehr detaillierte technische Spezifikation verweisen wir auf die kommerzielle Dokumentation.

(S)

För mera detaljerade tekniska data se kommersiell dokumentation.